

# Vue d'ensemble

<b>Aménagement intérieur</b>		Indice: <b>A</b>
Le 13/10/2014	N° plan: 1/1	A4
Destinateur: Emmanuel YVERTOT	Echelle: sans	ème
<b>MANU TECHNIQUE</b>		Technicien études bois agencement

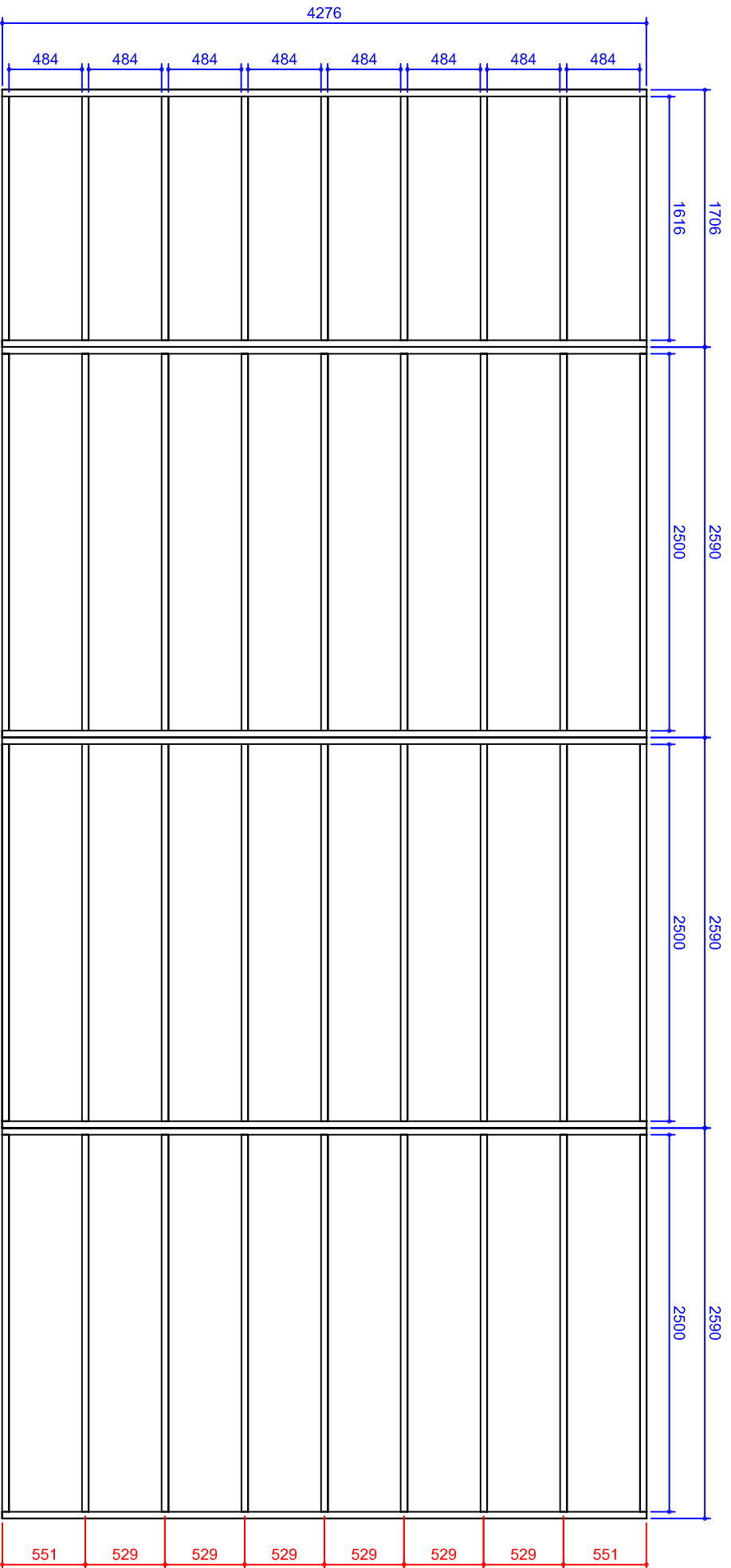

**Ossature plancher bas**  
(vue de dessus)

*Cotation Ossature*

*Cotation entre axe ossature*

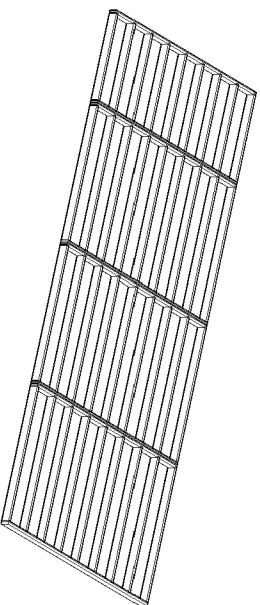

**Aménagement intérieur**

Indice: **A**

Le 13/10/2014

N° plan: 1/2

A4

Destinateur: Emmanuel YVERTOT

Echelle: 1/40

ème

**MANU TECHNIQUE**  
Technicien études bois agencement

Sens de pose

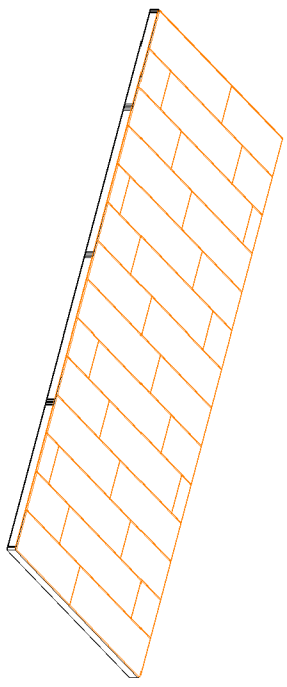
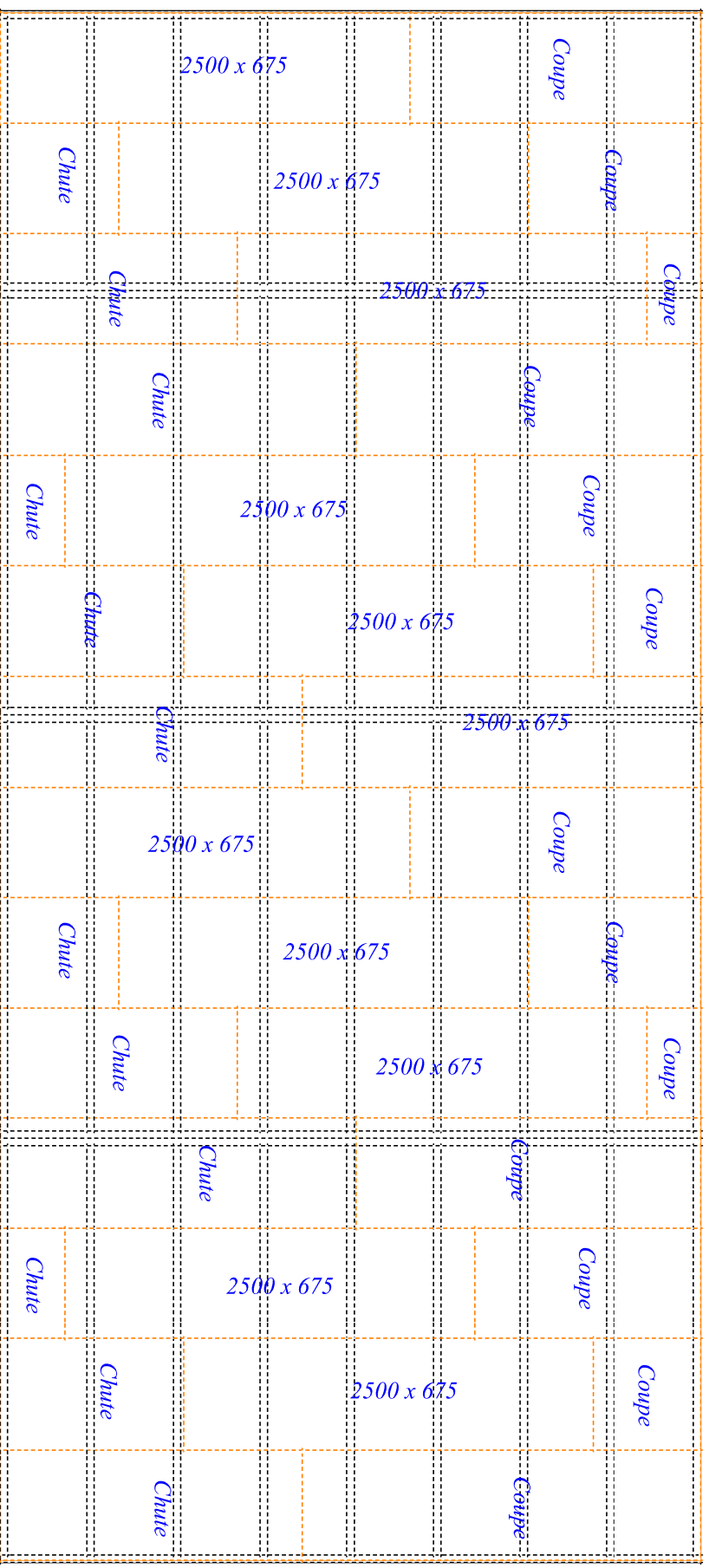

plancher bas OSB 22 mm  
(vue de dessus)

**Aménagement intérieur**

Le 13/10/2014		N° plan: 2/2		A4		Indice: 4	
Destinateur: Emmanuel YVERT		Echelle: 1/40		ème		MANU TECHNIQUE	
						Technicien études bois agencement	

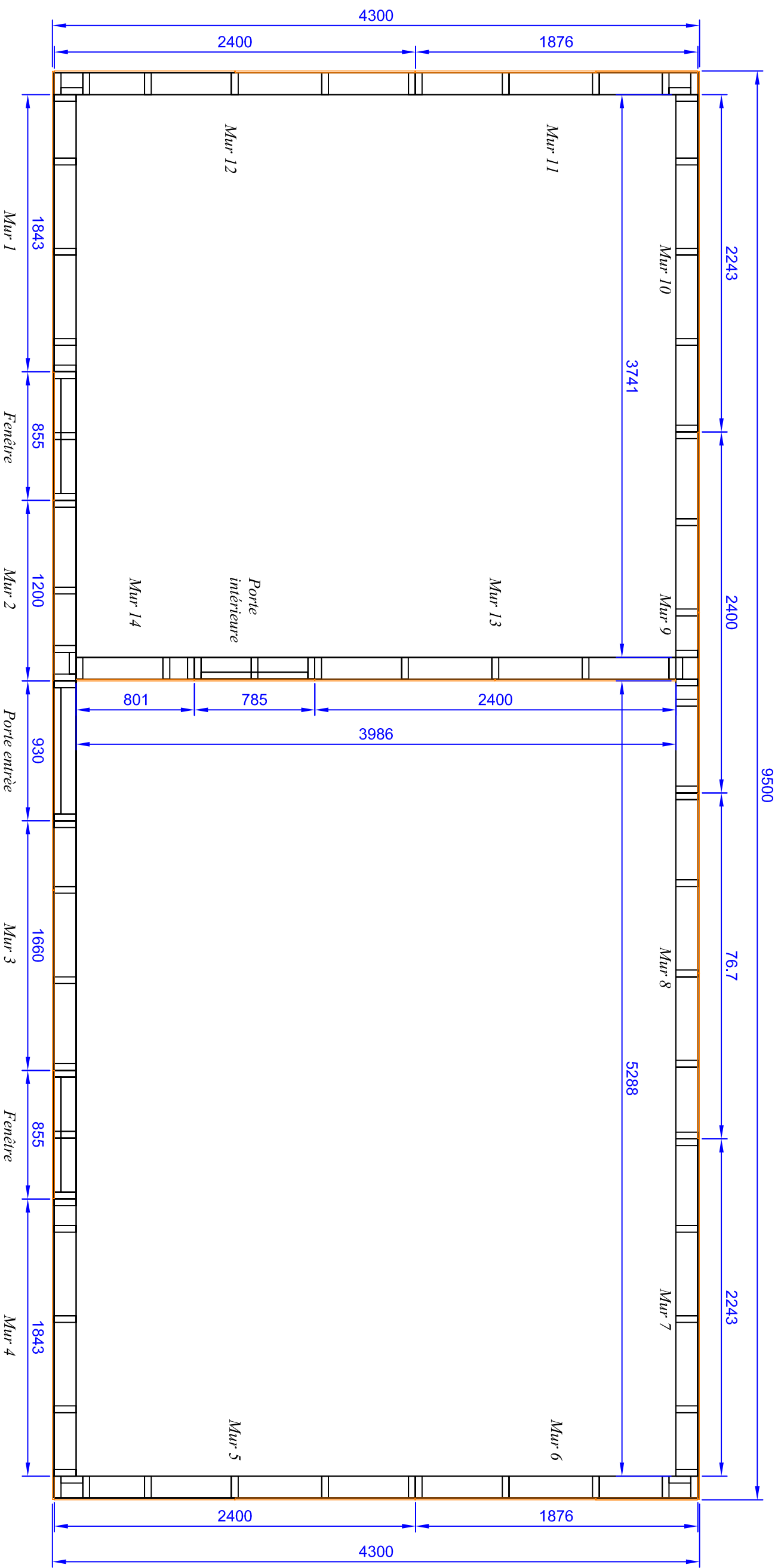

Murs ossature (vue de dessus)

 Ossature  
 OSB 12 mm

**Aménagement intérieur**

Indice: A

Le 13/10/2014

N° plan: 1/18

A3

Dessinateur: Emmanuel VIETOT

Echelle: 1/30

ème

**MANU TECHNIQUE**

Technicien études bois agencement

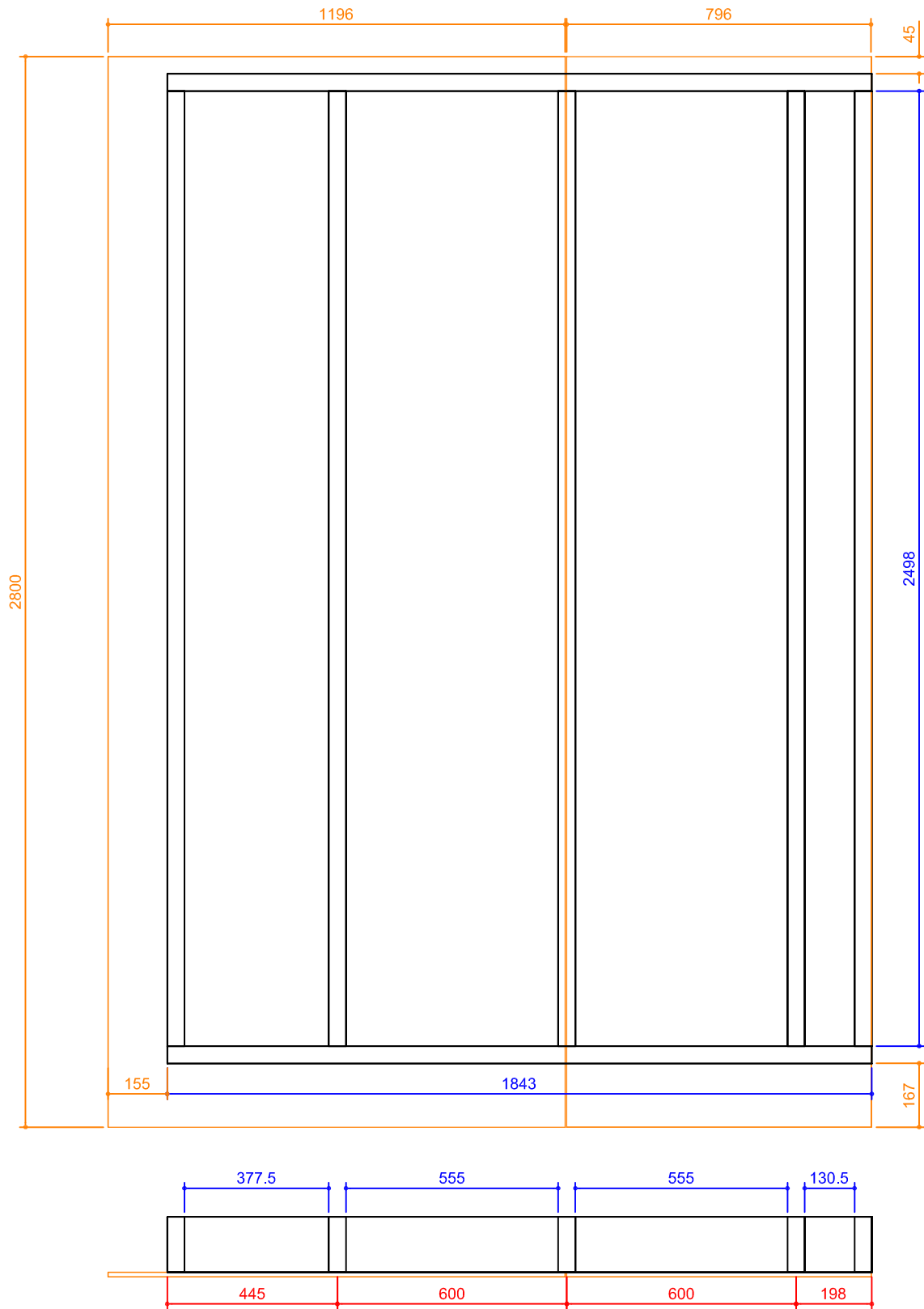

*Mur 1  
(vue extérieure)*

*Cotation OSB*

*Cotation Ossature*

*Cotation entre axe ossature*

<b>Aménagement intérieur</b>			Indice: <b>A</b>
Le 11/10/2014	N° plan: 2/18	A4	<b>MANU TECHNIQUE</b> Technicien études bois agencement
Dessinateur Emmanuel YVETOT	Echelle: 1/30	ème	

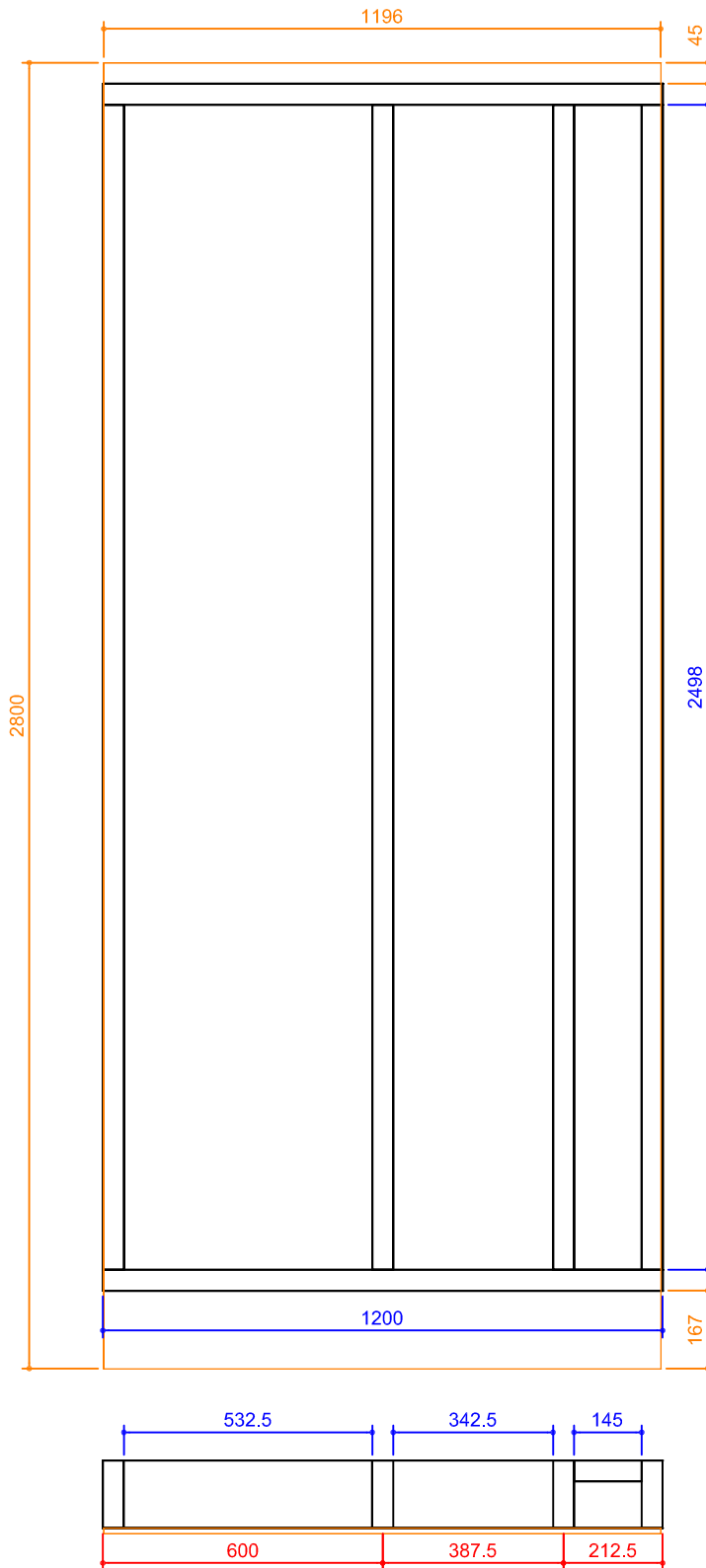

*Mur 2*  
*(vue extérieure)*

*Cotation OSB*

*Cotation Ossature*

*Cotation entre axe ossature*

<b>Aménagement intérieur</b>			Indice: <i>A</i>
Le 11/10/2014	N° plan: 3/18	A4	<b>MANU TECHNIQUE</b> Technicien études bois agencement
Dessinateur Emmanuel YVETOT	Echelle: 1/30	ème	

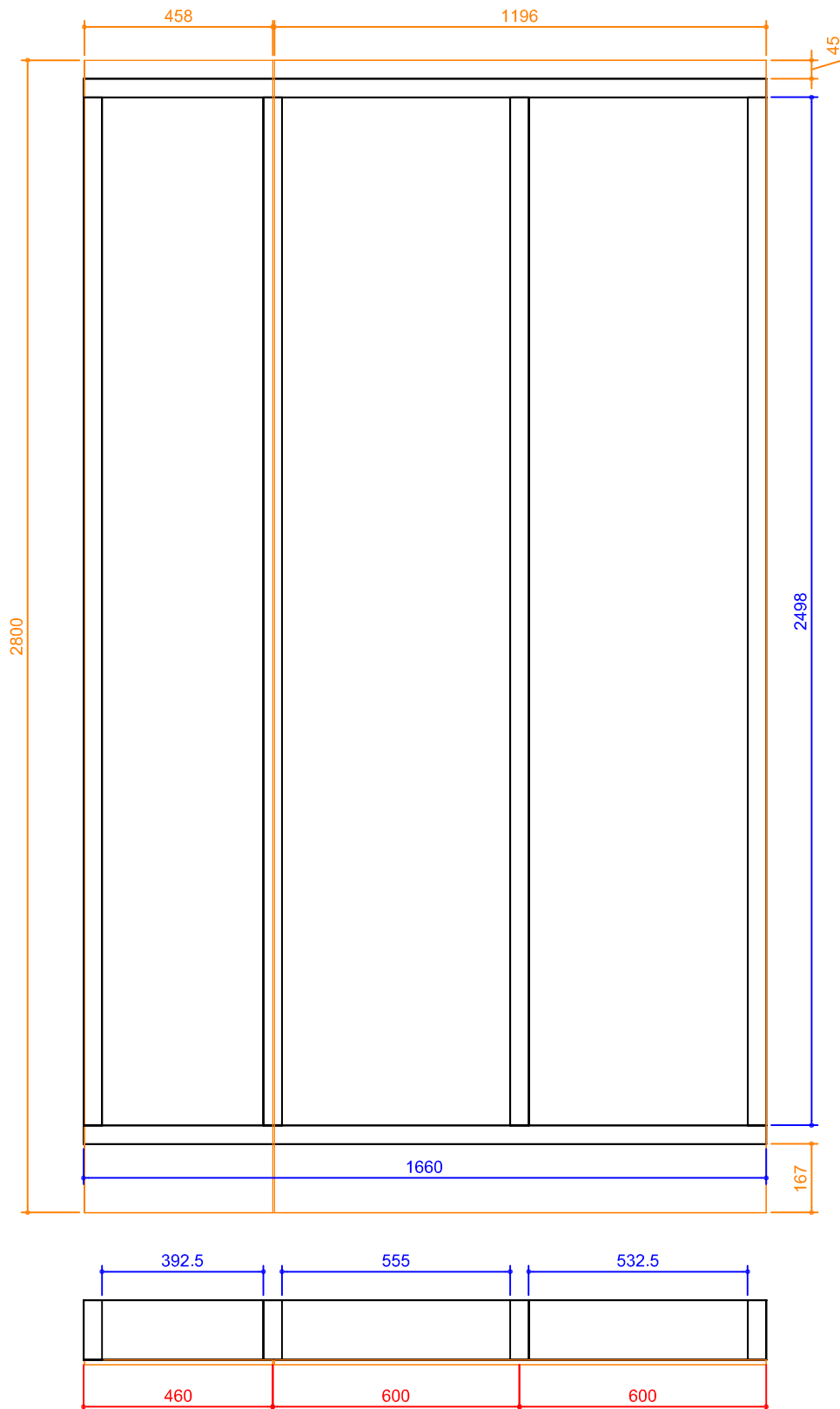

*Mur 3  
(vue extérieure)*

*Cotation OSB*

*Cotation Ossature*

*Cotation entre axe ossature*

<b>Aménagement intérieur</b>			Indice: <b>A</b>
Le 11/10/2014	N° plan: 4/18	A4	<b>MANU TECHNIQUE</b> Technicien études bois agencement
Dessinateur Emmanuel YVETOT	Echelle: 1/16	ème	

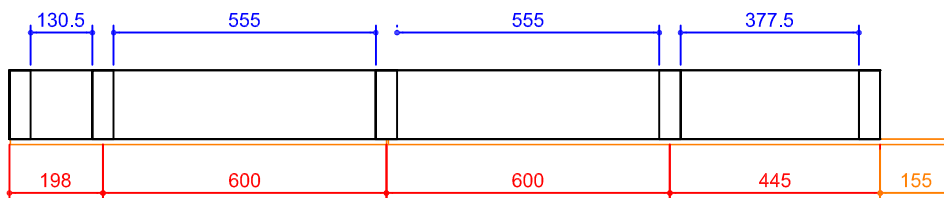
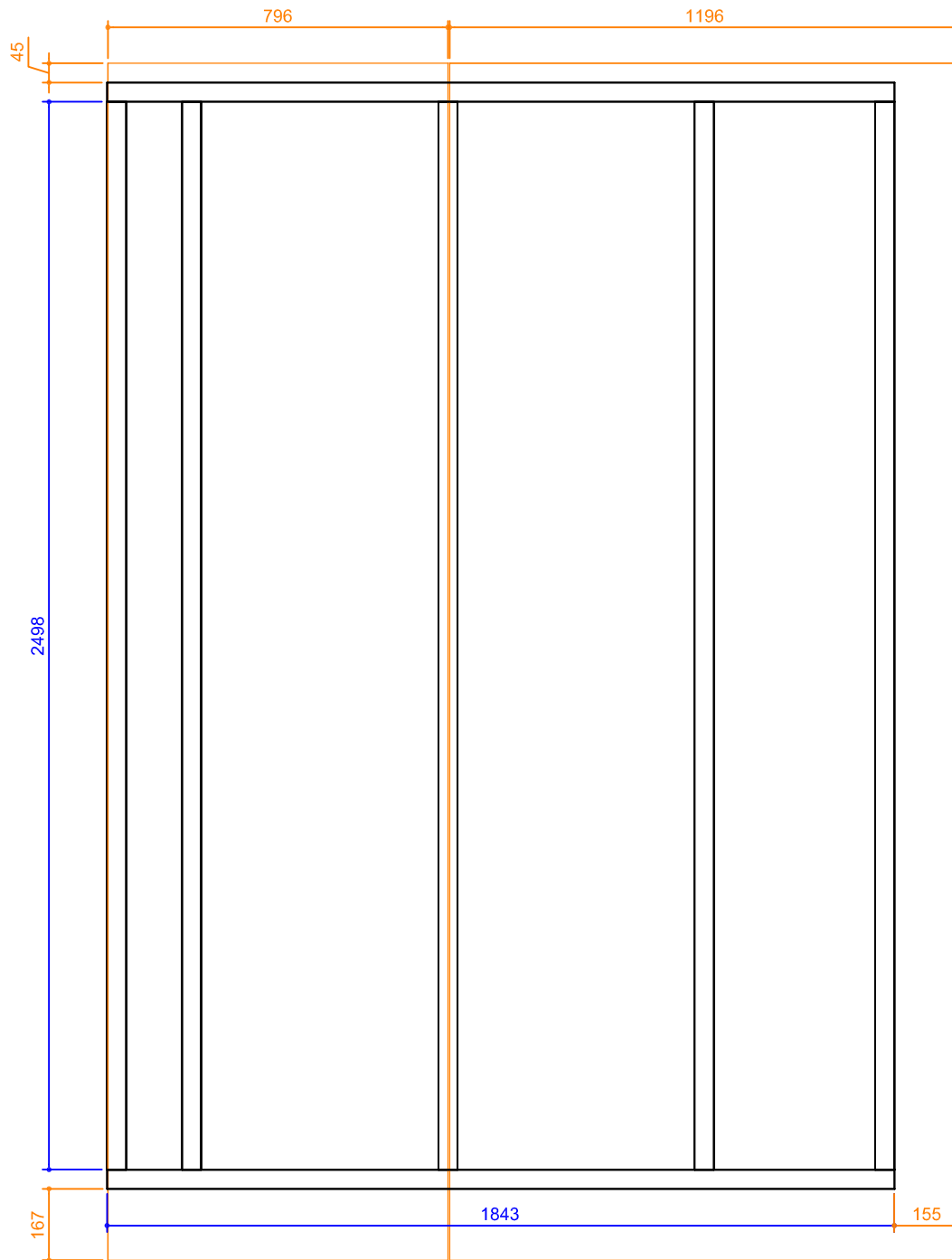

*Mur 4  
(vue extérieure)*

*Cotation OSB*

*Cotation Ossature*

*Cotation entre axe ossature*

<b>Aménagement intérieur</b>			Indice: <b>A</b>
Le 11/10/2014	N° plan: 5/18	<b>A4</b>	<b>MANU TECHNIQUE</b> Technicien études bois agencement
Dessinateur Emmanuel YVETOT	Echelle: 1/16	ème	



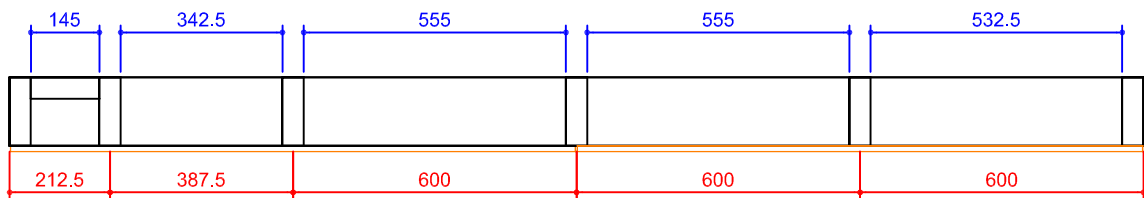
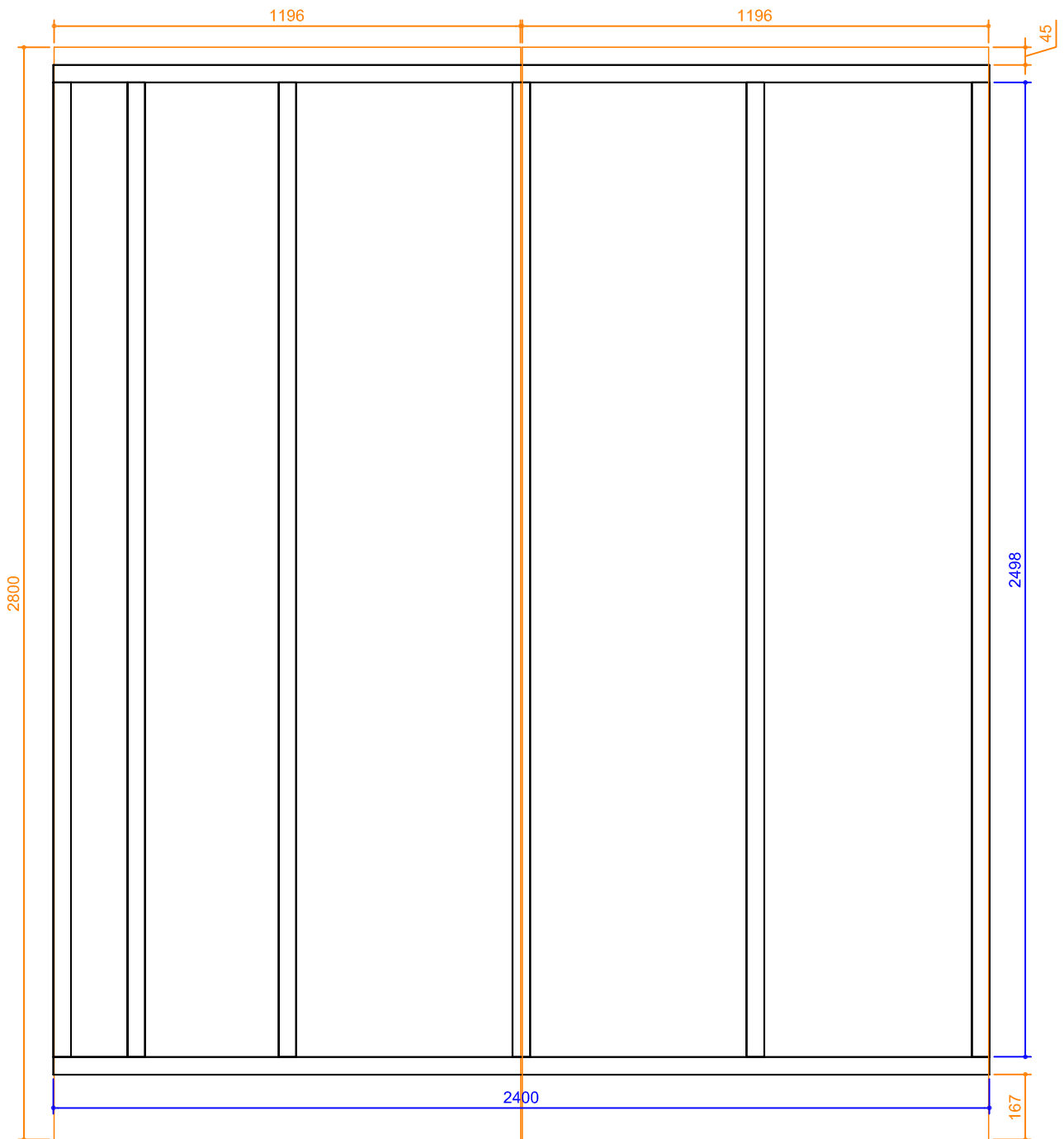

*Mur 5  
(vue extérieure)*

*Cotation OSB*

*Cotation Ossature*

*Cotation entre axe ossature*

<b>Aménagement intérieur</b>			Indice: <b>A</b>
Le 11/10/2014	N° plan: 6/18	A4	<b>MANU TECHNIQUE</b> Technicien études bois agencement
Dessinateur Emmanuel YVETOT	Echelle: 1/16	ème	

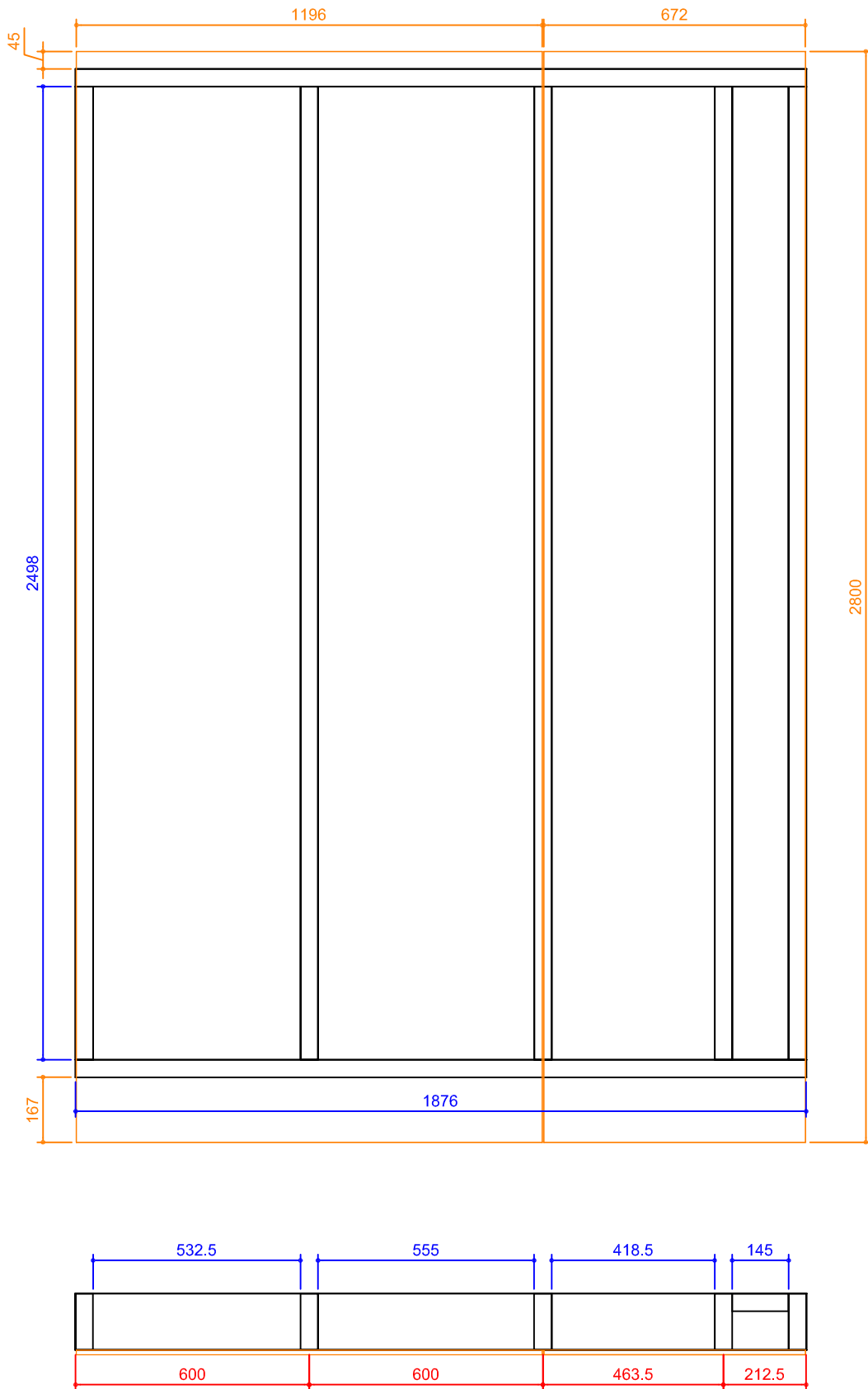

*Mur 6  
(vue extérieure)*

*Cotation OSB*

*Cotation Ossature*

*Cotation entre axe ossature*

<b>Aménagement intérieur</b>			Indice: <b>A</b>
Le 11/10/2014	N° plan: 7/18	A4	<b>MANU TECHNIQUE</b> Technicien études bois agencement
Dessinateur Emmanuel YVETOT	Echelle: 1/16	ème	

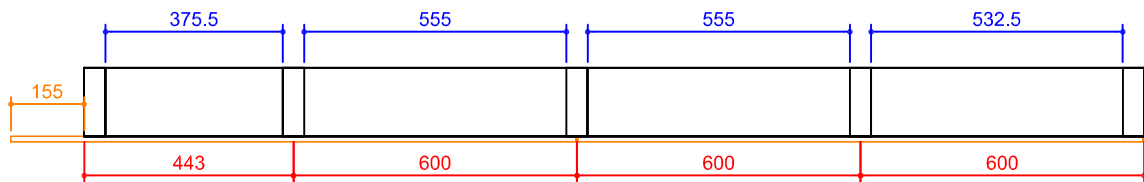
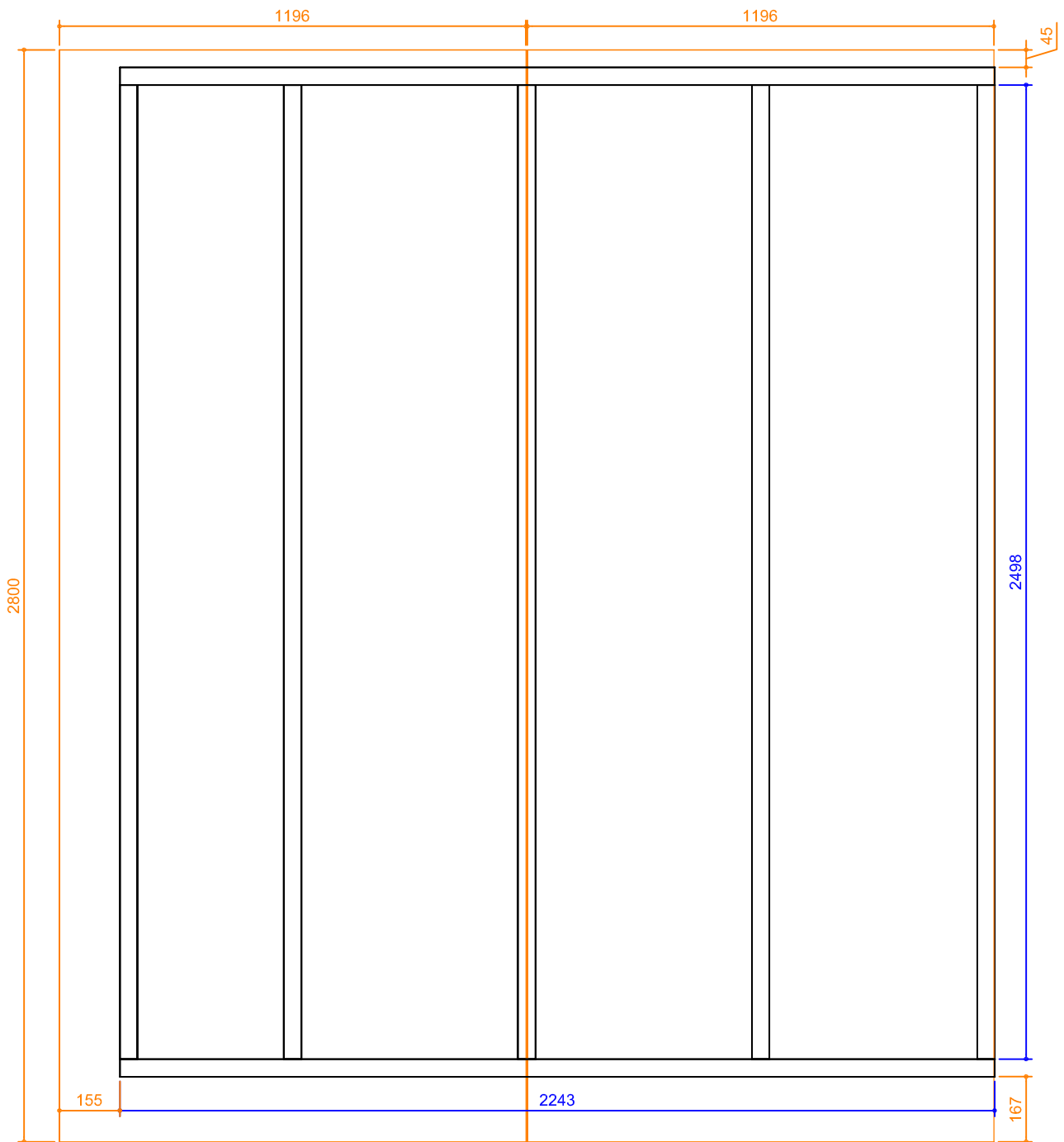

*Mur 7  
(vue extérieure)*

*Cotation OSB*

*Cotation Ossature*

*Cotation entre axe ossature*

<b>Aménagement intérieur</b>			Indice: <b>A</b>
Le 11/10/2014	N° plan: 8/18	<b>A4</b>	<b>MANU TECHNIQUE</b> Technicien études bois agencement
Dessinateur Emmanuel YVETOT	Echelle: 1/16	ème	

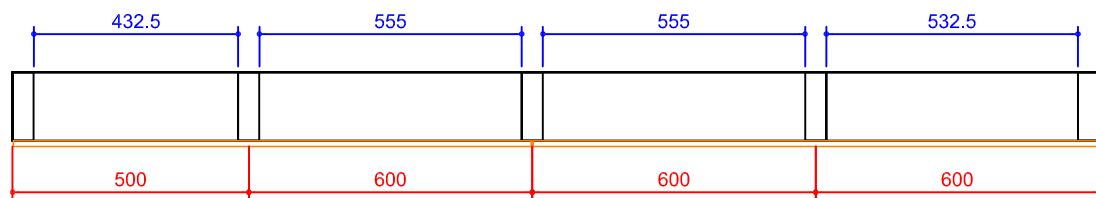
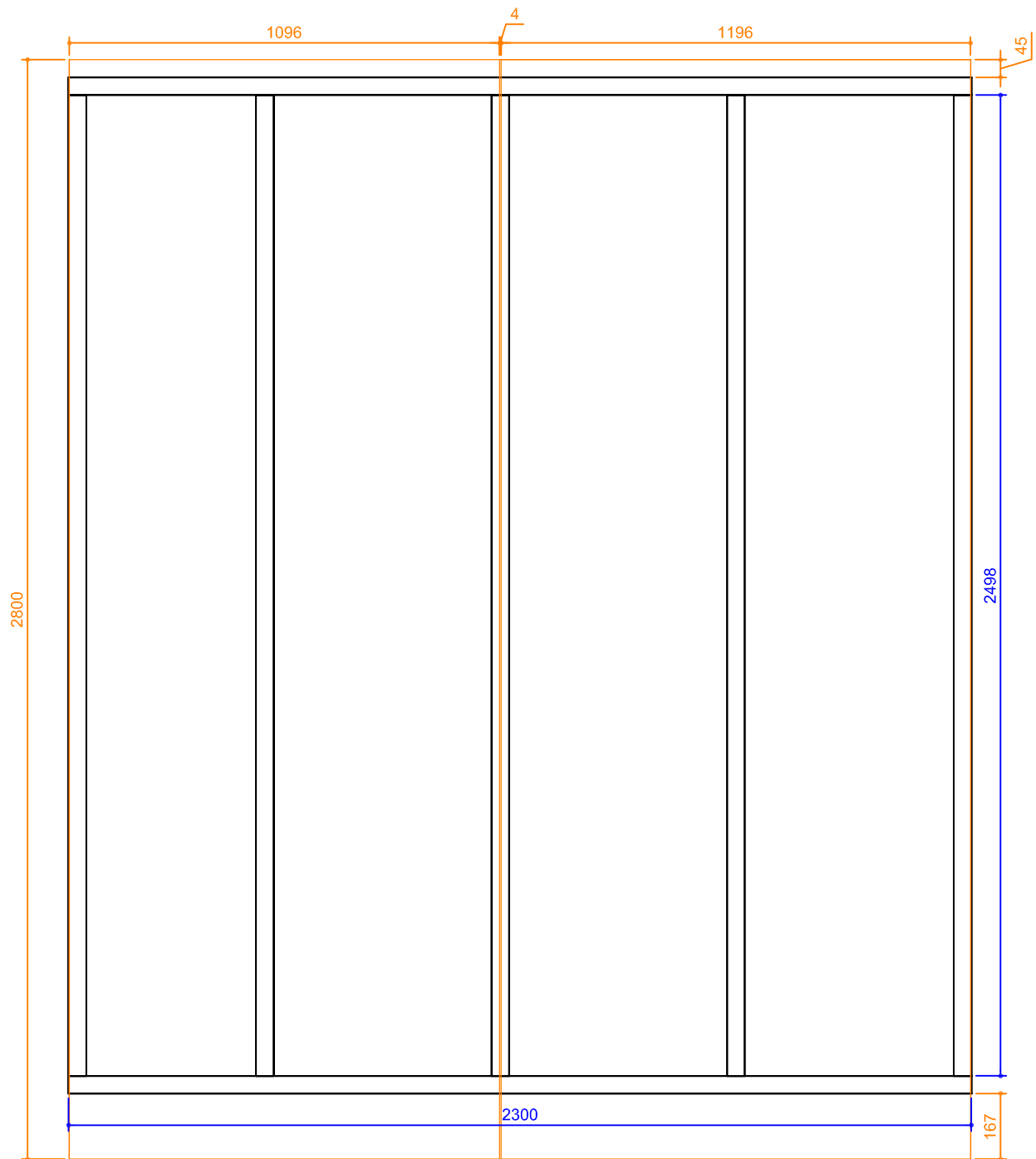

*Mur 8  
(vue extérieure)*

*Cotation OSB*

*Cotation Ossature*

*Cotation entre axe ossature*

<b>Aménagement intérieur</b>			Indice: <b>A</b>
Le 11/10/2014	N° plan: 9/18	A4	<b>MANU TECHNIQUE</b> Technicien études bois agencement
Dessinateur Emmanuel YVETOT	Echelle: 1/16	ème	

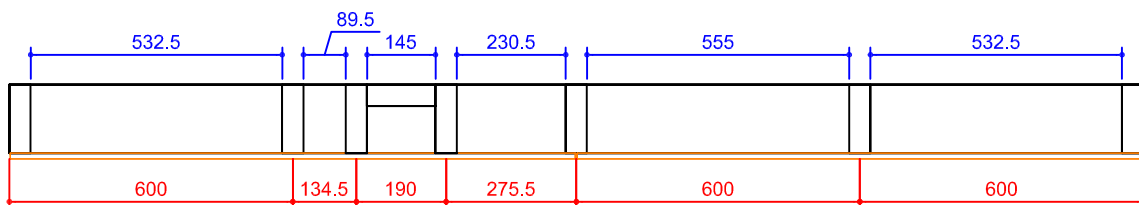
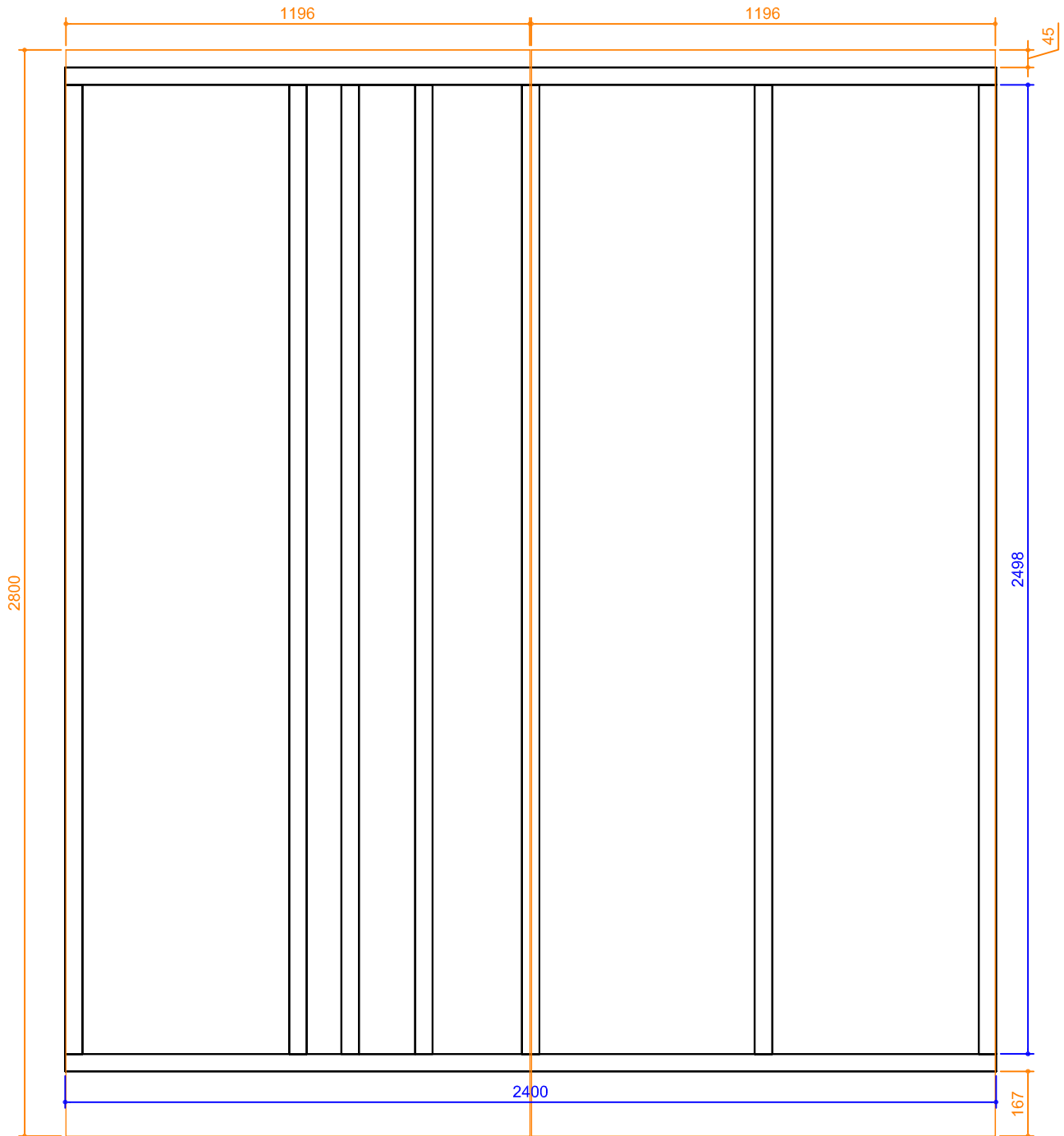

*Mur 9  
(vue extérieure)*

*Cotation OSB*

*Cotation Ossature*

*Cotation entre axe ossature*

<b>Aménagement intérieur</b>			Indice: <b>A</b>
Le 11/10/2014	N° plan: 10/18	A4	<b>MANU TECHNIQUE</b> Technicien études bois agencement
Dessinateur Emmanuel YVETOT	Echelle: 1/16	ème	

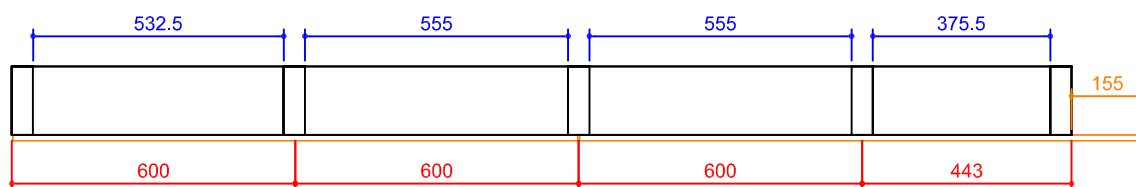
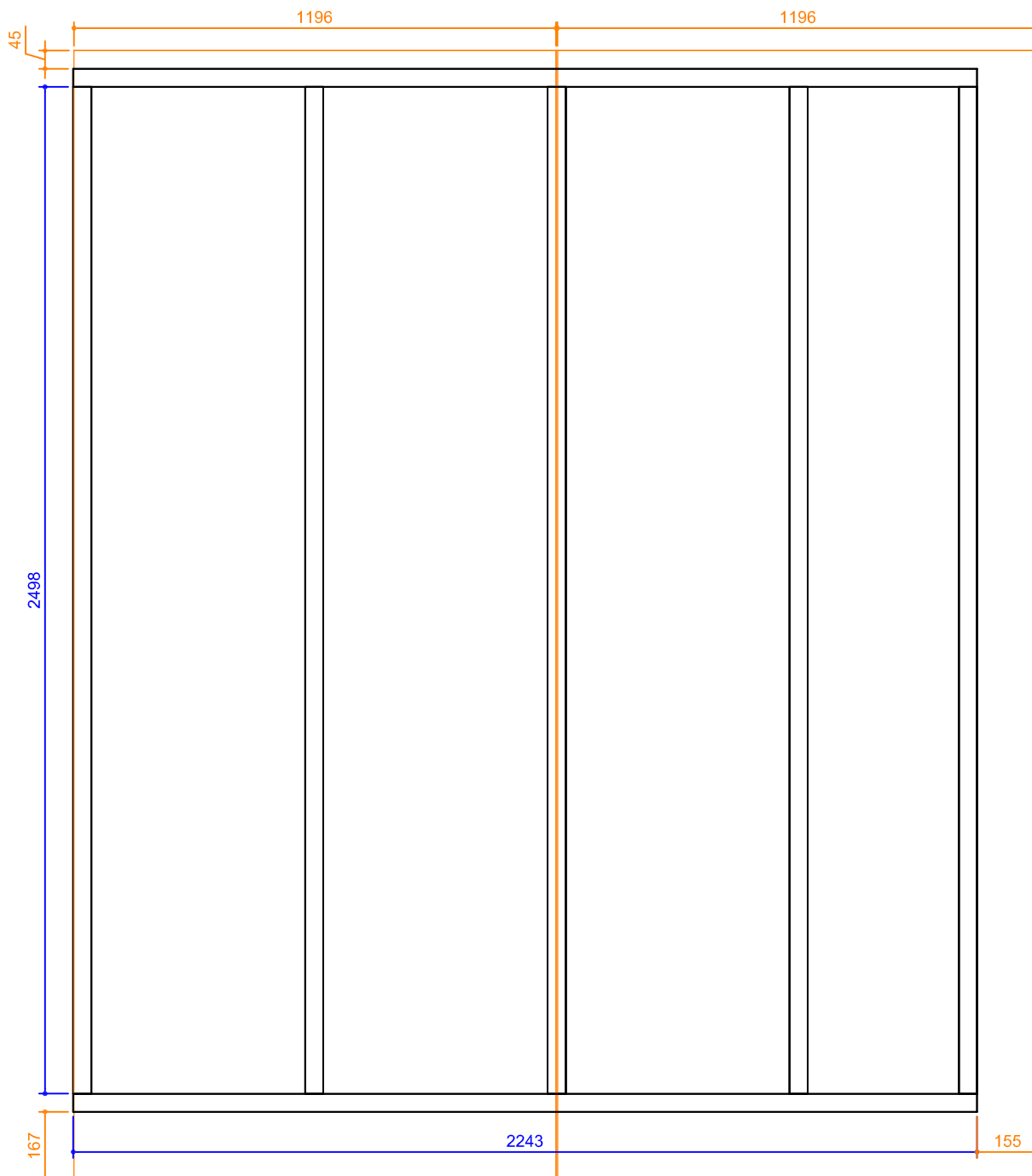

*Mur 10  
(vue extérieure)*

*Cotation OSB*

*Cotation Ossature*

*Cotation entre axe ossature*

<b>Aménagement intérieur</b>			Indice: <b>A</b>
Le 11/10/2014	N° plan: 11/18	A4	<b>MANU TECHNIQUE</b> Technicien études bois agencement
Dessinateur Emmanuel YVETOT	Echelle: 1/16	ème	

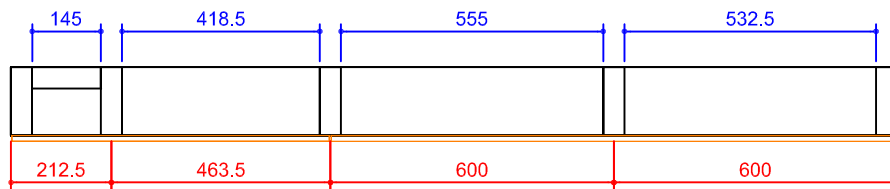
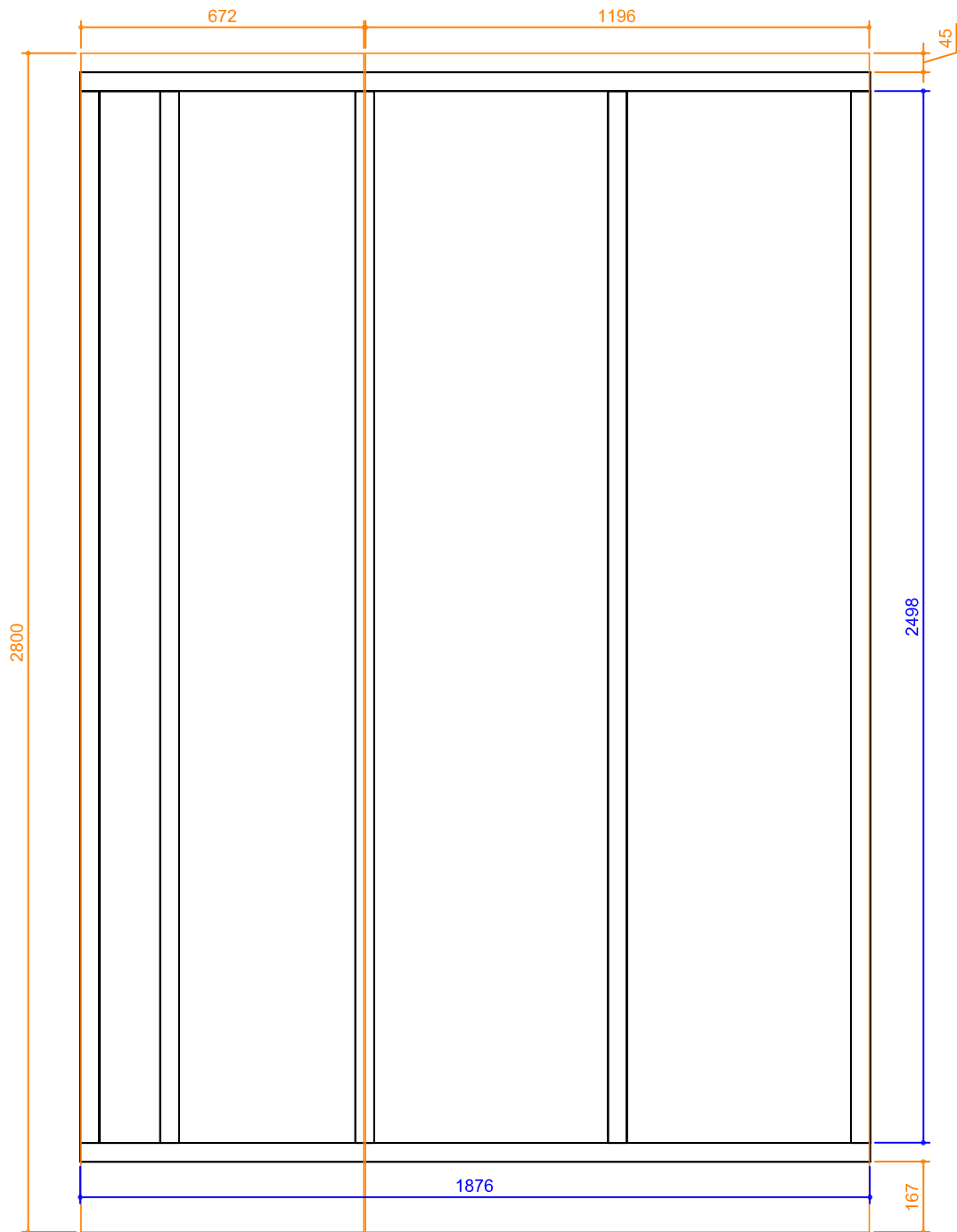

*Mur 11  
(vue extérieure)*

*Cotation OSB*

*Cotation Ossature*

*Cotation entre axe ossature*

<b>Aménagement intérieur</b>			Indice: <b>A</b>
Le 11/10/2014	N° plan: 12/18	A4	<b>MANU TECHNIQUE</b> Technicien études bois agencement
Dessinateur Emmanuel YVETOT	Echelle: 1/16	ème	

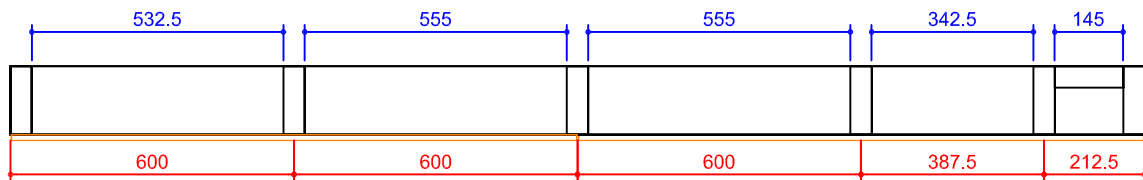
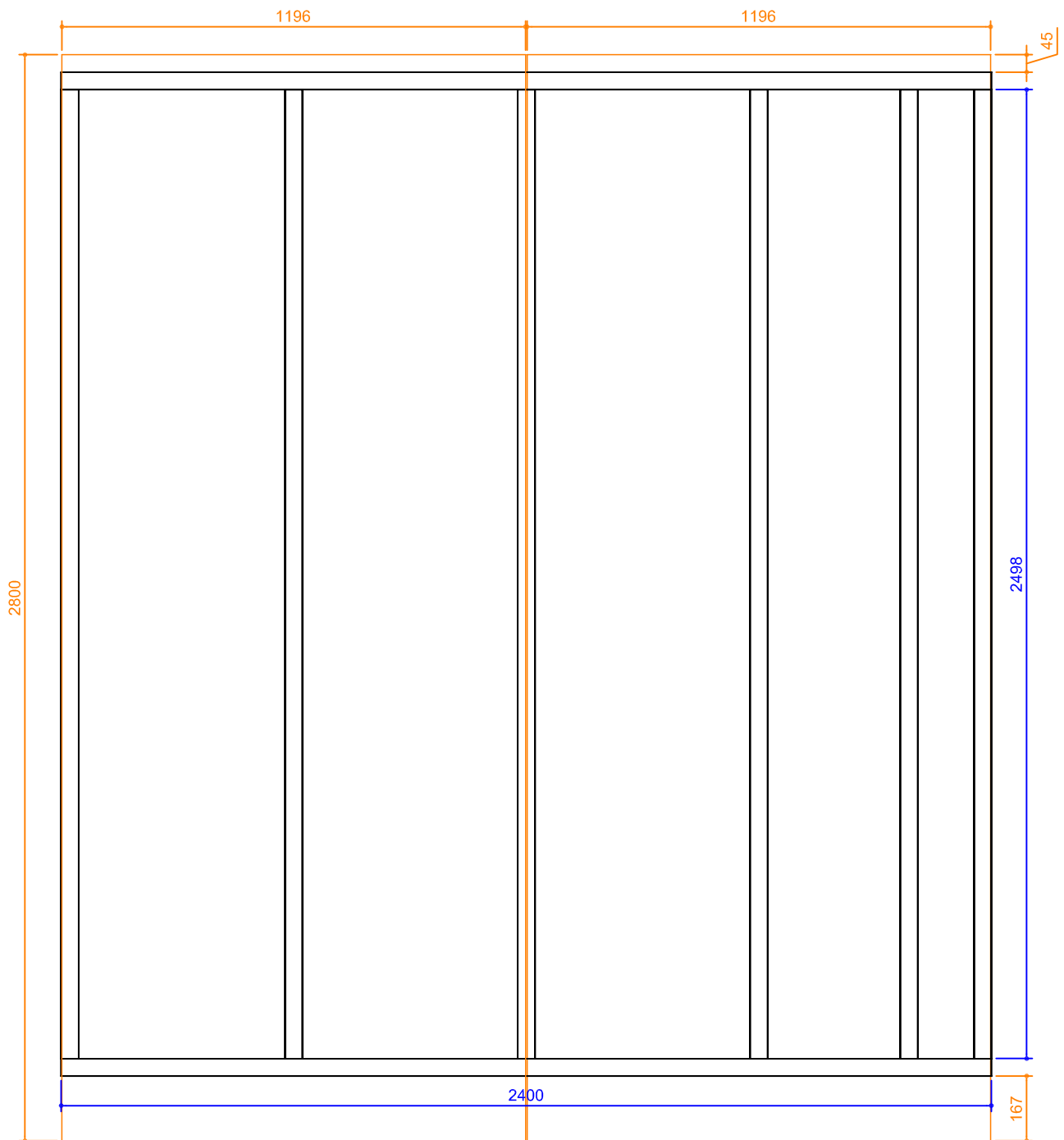

*Mur 12  
(vue extérieure)*

*Cotation OSB*

*Cotation Ossature*

*Cotation entre axe ossature*

<b>Aménagement intérieur</b>			Indice: <b>A</b>
Le 11/10/2014	N° plan: 13/18	A4	<b>MANU TECHNIQUE</b> Technicien études bois agencement
Dessinateur Emmanuel YVETOT	Echelle: 1/16	ème	



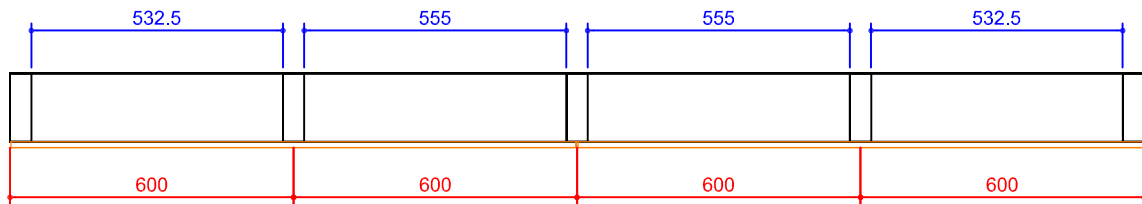
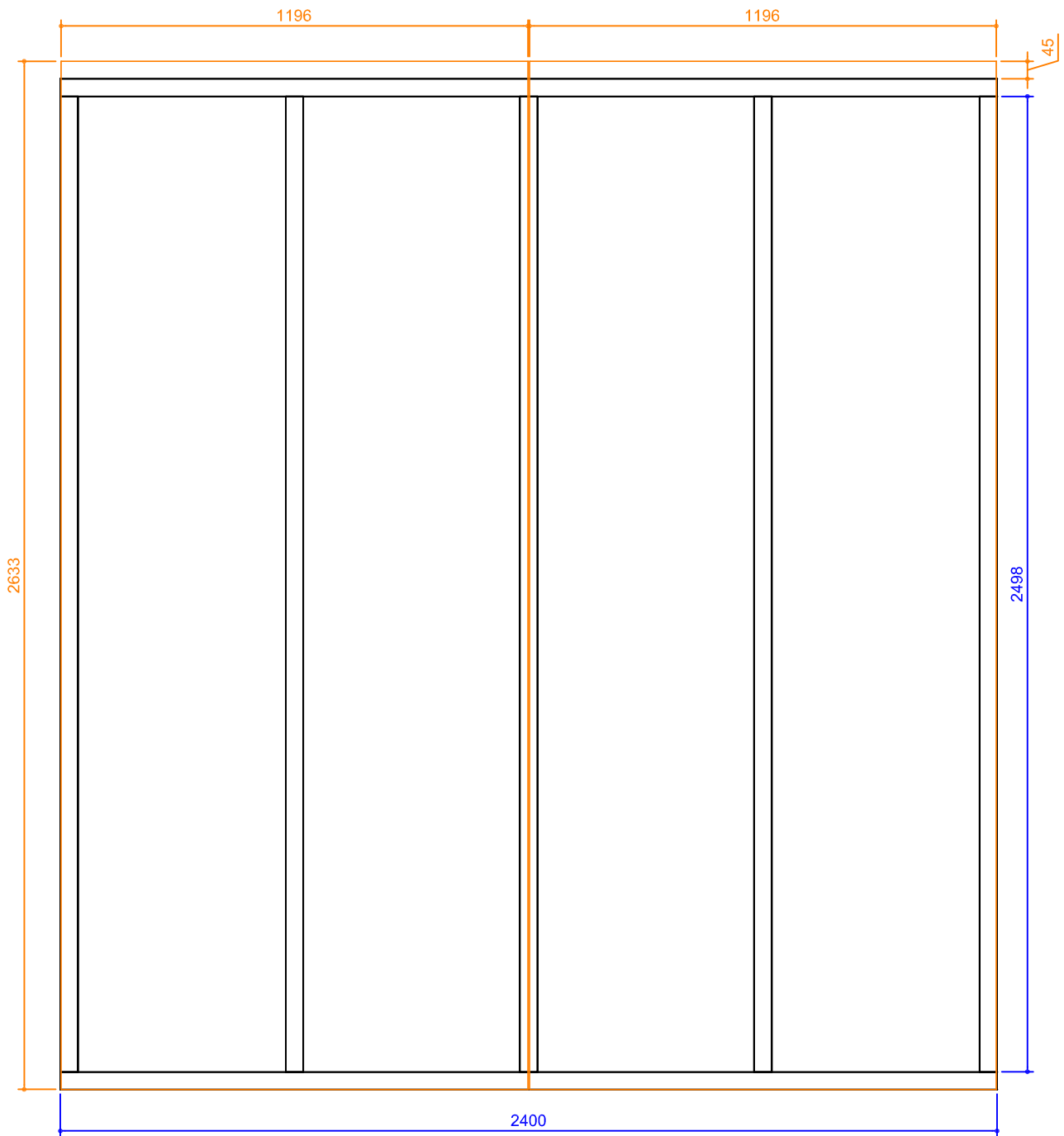

*Mur 13  
(vue extérieure)*

*Cotation OSB*

*Cotation Ossature*

*Cotation entre axe ossature*

<b>Aménagement intérieur</b>			Indice: <b>A</b>
Le 11/10/2014	N° plan: 14/18	A4	<b>MANU TECHNIQUE</b> Technicien études bois agencement
Dessinateur Emmanuel YVETOT	Echelle: 1/16	ème	

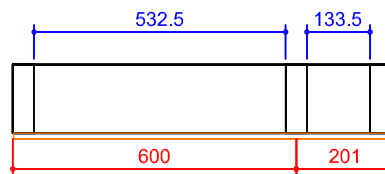
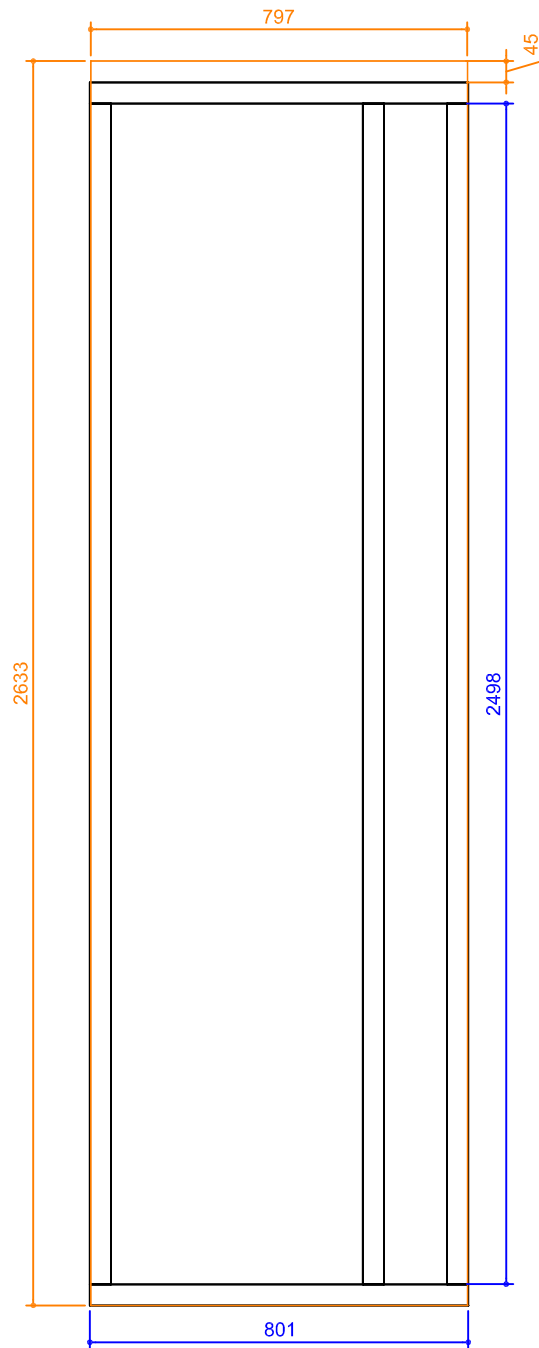

*Mur 14  
(vue extérieure)*

*Cotation OSB*

*Cotation Ossature*

*Cotation entre axe ossature*

<b>Aménagement intérieur</b>			Indice: <i>A</i>
Le 11/10/2014	N° plan: 15/18	<b>A4</b>	<b>MANU TECHNIQUE</b> Technicien études bois agencement
Dessinateur Emmanuel YVETOT	Echelle: 1/16	<sup>ème</sup>	

*Imposte*

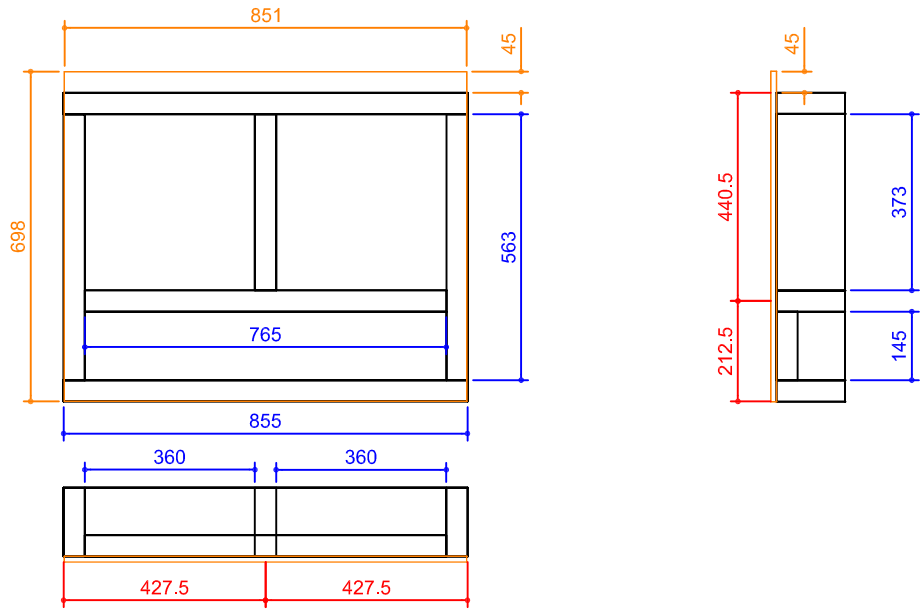

*Allège*

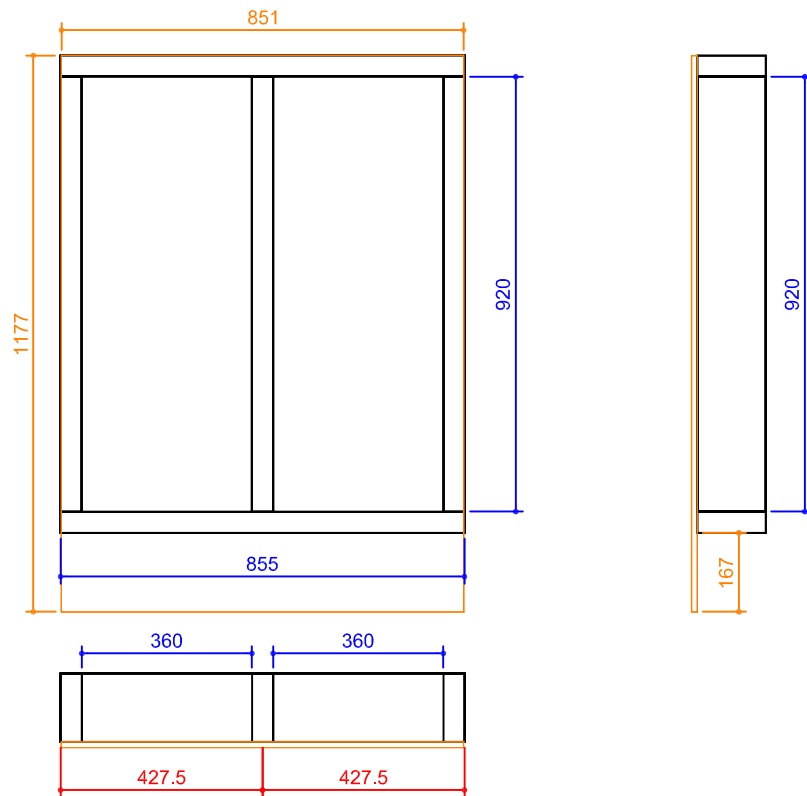

*Fenêtre  
(vue extérieure)*

*Cotation OSB*

*Cotation Ossature*

*Cotation entre axe ossature*

<b>Aménagement intérieur</b>			Indice: <b>A</b>
Le 11/10/2014	N° plan: 16/18	A4	<b>MANU TECHNIQUE</b> Technicien études bois agencement
Dessinateur Emmanuel YVETOT	Echelle: 1/16	ème	

*Imposte  
Porte entrée*

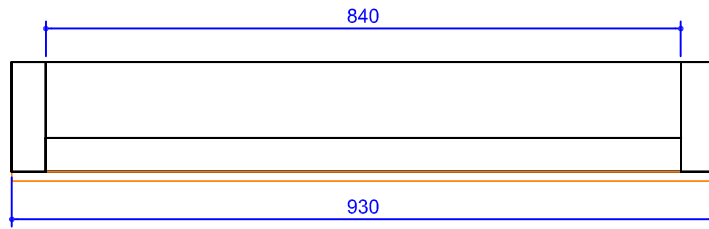
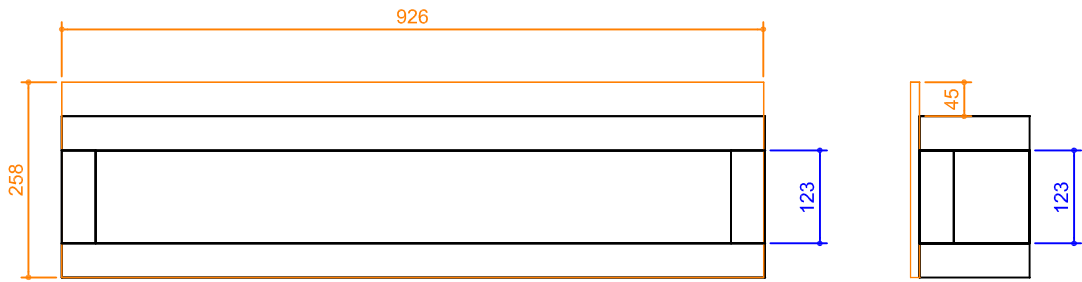

*Imposte  
Porte intérieure*

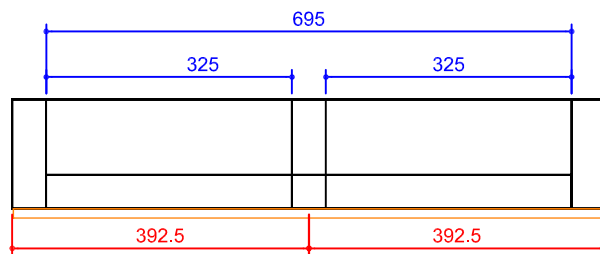
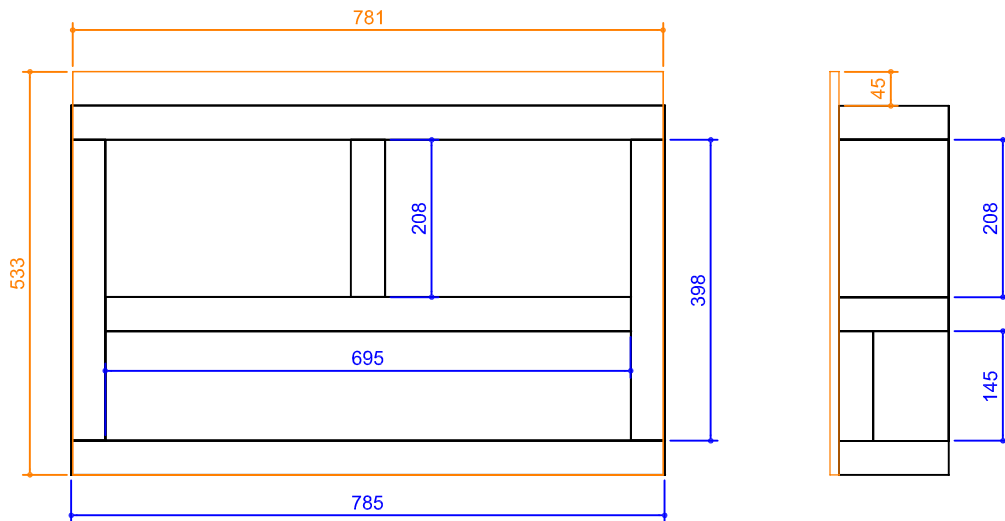

*Porte  
(vue extérieure)*

*Cotation OSB*

*Cotation Ossature*

*Cotation entre axe ossature*

<b>Aménagement intérieur</b>			Indice: <b>A</b>
Le 11/10/2014	N° plan: 17/18	A4	<b>MANU TECHNIQUE</b> Technicien études bois agencement
Dessinateur Emmanuel YVETOT	Echelle: 1/16	ème	

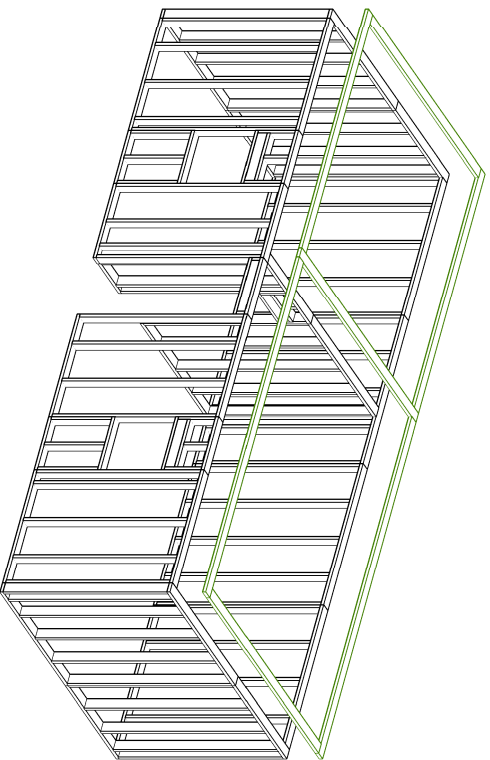
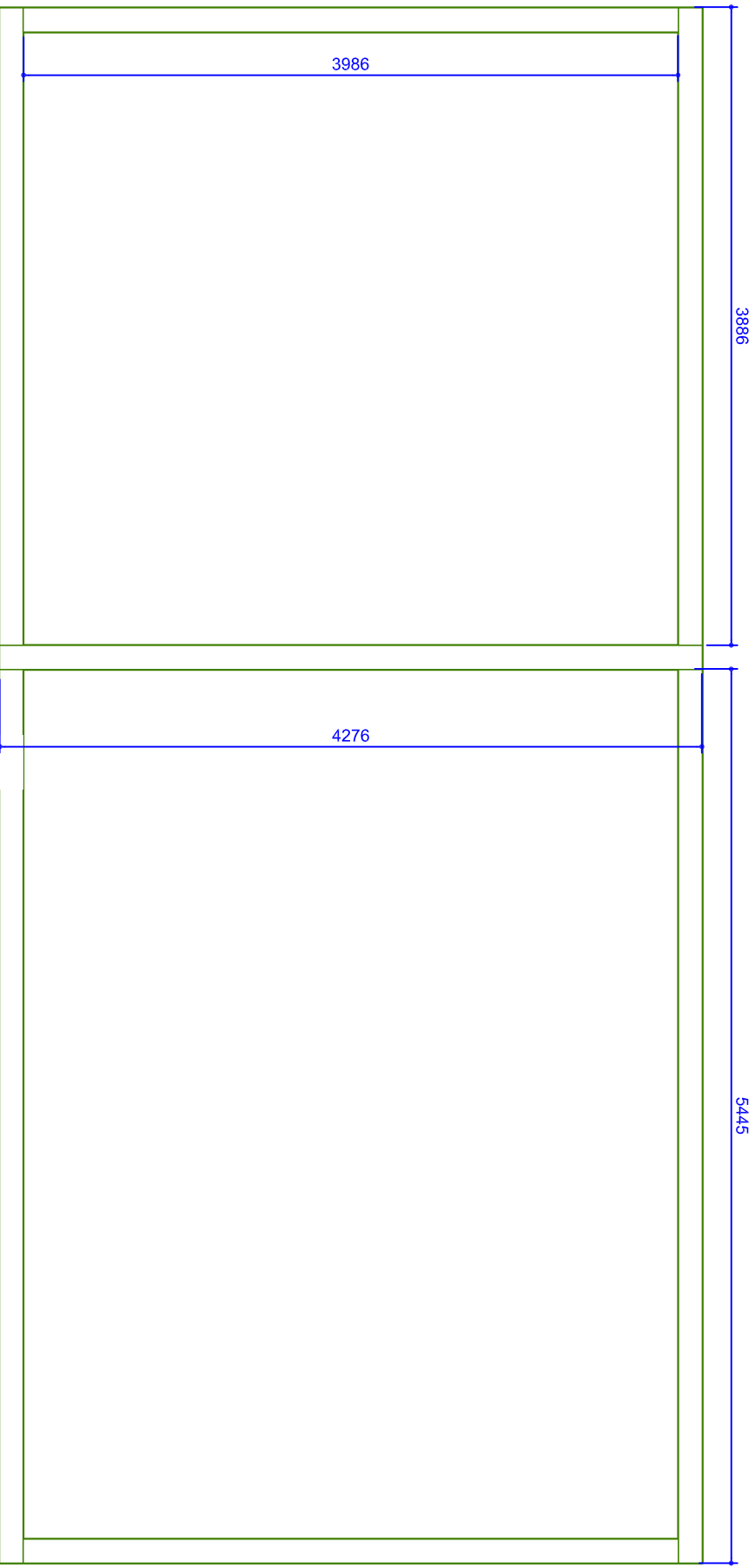

*Lisse haute  
(vue de dessus)*

***Aménagement intérieur***

Indice: **A**

Le 13/10/2014

N° plan: 18/18

A4

Destinateur: Emmanuel YVERT

Echelle: 1/16

ème

**MANU TECHNIQUE**

Technicien études bois agencement

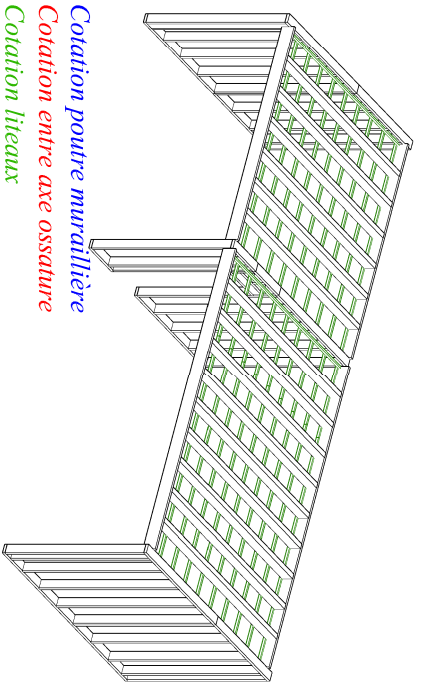
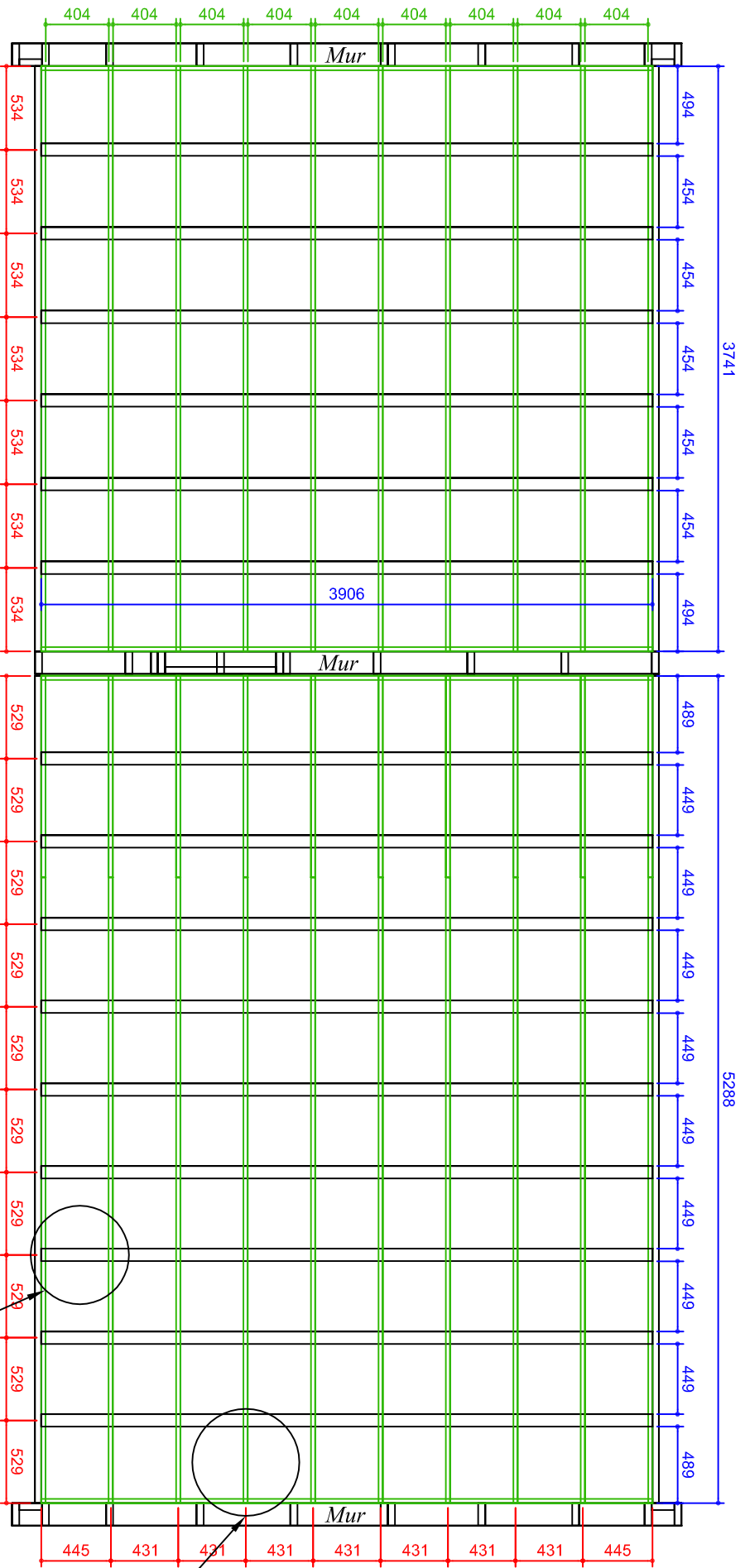

Cotation poutre muraille  
 Cotation entre axe ossature  
 Cotation liteaux

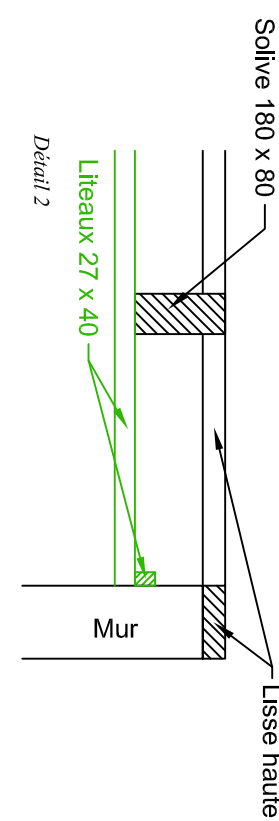
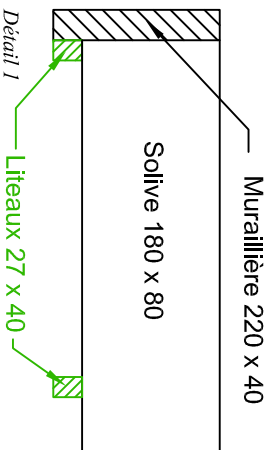

Solvage haut  
 (vue de dessus)

<b>Aménagement intérieur</b>			Indice: <b>A</b>
Le	13/10/2014	N° plan: 1/2	A4
Destinateur	Emmanuel YVERT	Echelle: 1/40	ème
<b>MANU TECHNIQUE</b>			
Technicien études bois agencement			

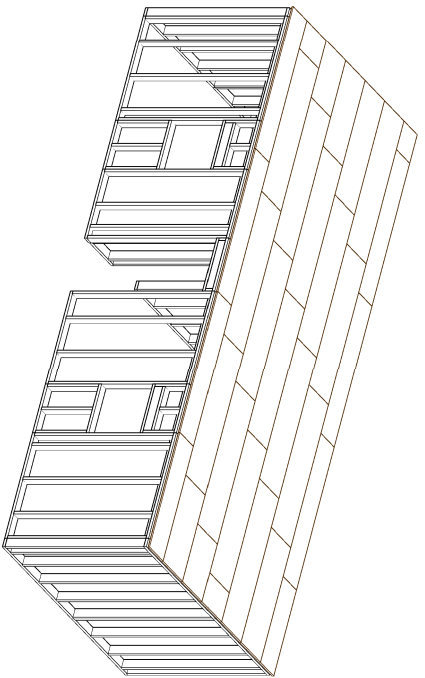
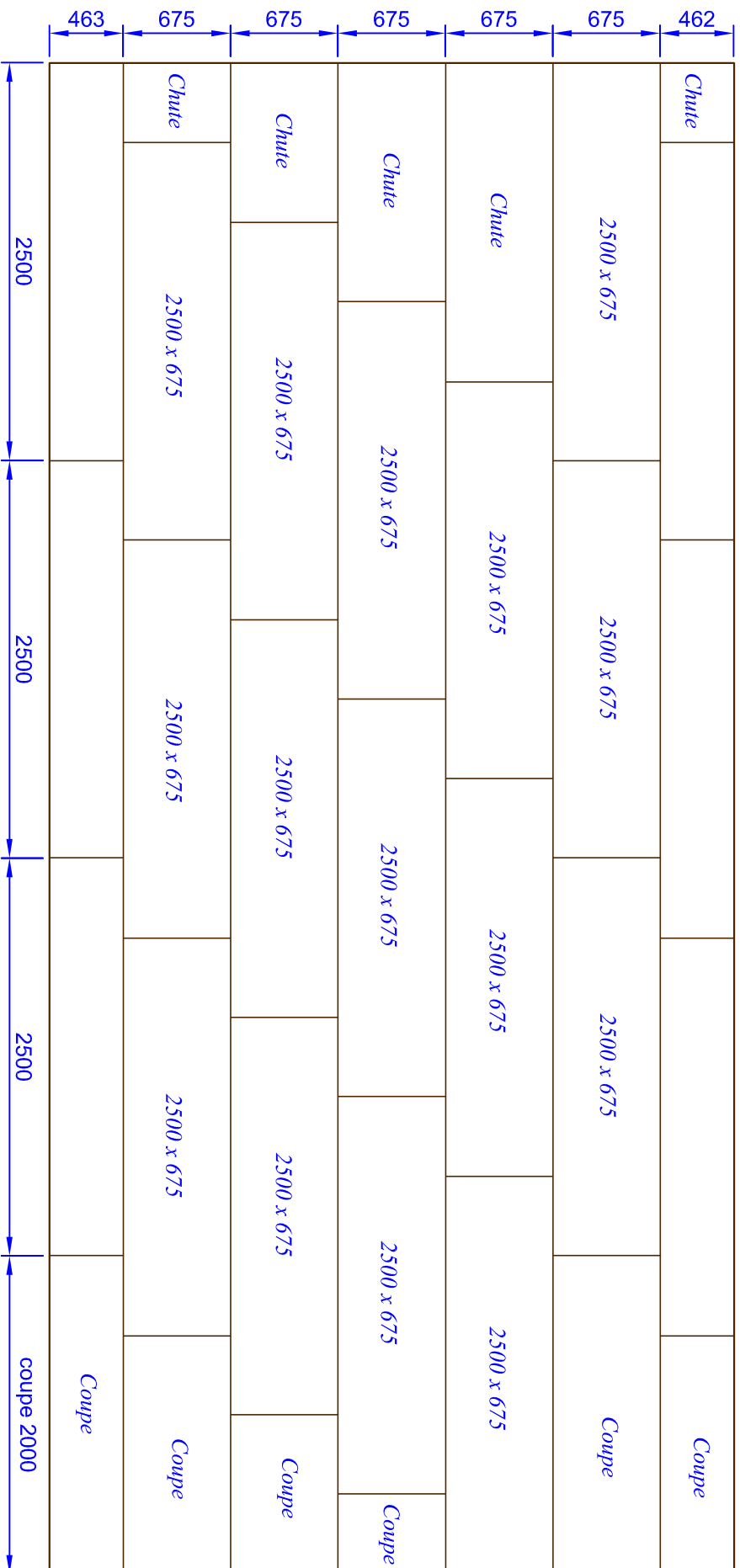

*Plancher haut  
(vue de dessus)*

**Sens de pose** →

**Sens de pose** →

**Aménagement intérieur**

Indice: **A**

Le 13/10/2014

N° plan: 2/2

A4

ème

Destinateur: Emmanuel YVERT

Echelle: 1/40

**MANU TECHNIQUE**  
Technicien études bois agencement